

**PSLE STANDARD MATHEMATICS**

**PAPER 1**

**(45 marks)**

**Booklet A (20 marks)**

**Questions 1 to 10 carry 1 mark each. Questions 11 to 15 carry 2 marks each. For each question, four options are given. One of them is the correct answer. Write your answer (1, 2, 3 or 4) in the brackets provided. All diagrams in this paper are not drawn to scale unless stated otherwise.**

**The use of calculators is NOT allowed.**

1.  $7\ 809\ 621 = 7\ 000\ 000 + \underline{\hspace{2cm}} + 9000 + 600 + 20 + 1$   
What is the missing number in the blank?

- (1) 800
- (2) 8000
- (3) 80 000
- (4) 800 000

( )

2. Which of the following numbers are common factors of 16 and 24?

- (1) 8 and 12
- (2) 2 and 3
- (3) 4 and 6
- (4) 4 and 8

( )

3. Express 0.5 as a percentage.

- (1) 0.005%
- (2) 0.05%
- (3) 5%
- (4) 50%

( )

4. Andy is 12 years old. He is  $z$  years older than Ben. How old is Ben?

- (1)  $(12 + z)$  years old
- (2)  $(12 - z)$  years old
- (3)  $(z)$  years old
- (4)  $(12 + z)$  years old

( )

5. Which of the following fractions has the largest value?

(1)  $\frac{7}{9}$

(2)  $\frac{6}{11}$

(3)  $\frac{4}{7}$

(4)  $\frac{2}{3}$

( )

6. Sandy had 6 coins in her purse as shown. She took out only 4 coins to pay the exact amount for a sandwich.

Which of the following amounts is **not** a possible cost for the sandwich?

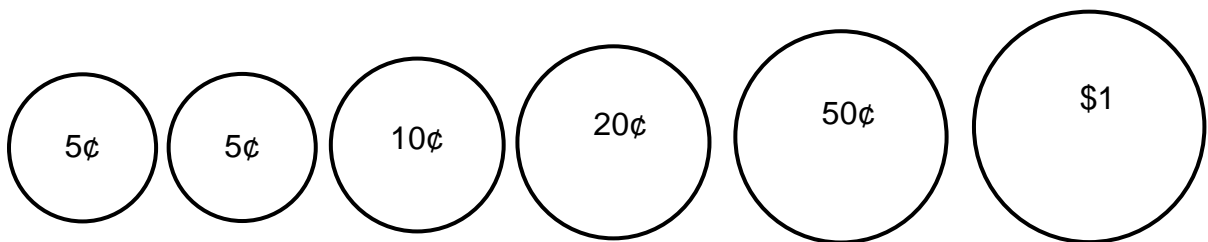

- (1) \$1.65
- (2) \$1.40
- (3) \$1.35
- (4) \$1.30

( )

7. The average of 5 numbers is 14. When a 6<sup>th</sup> number is added, the average now becomes 14. What is the 6<sup>th</sup> number?

- (1) 12
- (2) 14
- (3) 28
- (4) 30

( )

8. In the diagram, point A is north of point B and  $\angle ABC = 140^\circ$ . In what direction is point C from point B?

- (1) North-East
- (2) North-West
- (3) South-East
- (4) South-West

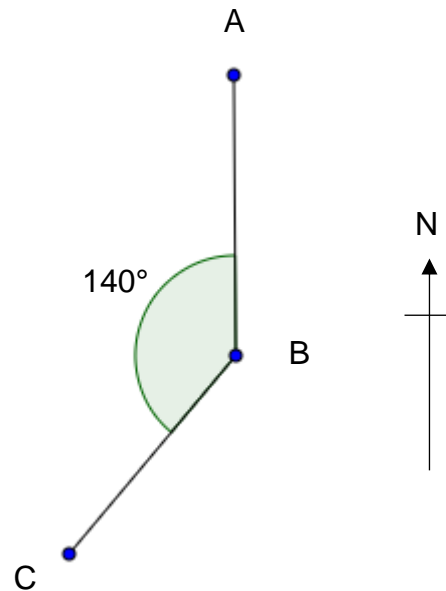

( )

9. The following pie chart shows the number of tickets for a show sold on a certain day. The total number of tickets sold on that day was 860. Find the number of senior citizen tickets sold on that day.

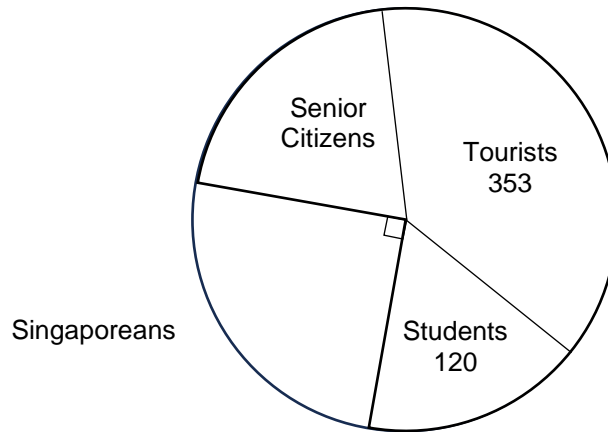

- (1) 172
- (2) 215
- (3) 335
- (4) 525

( )

10. There were 84 children. 51 of them were boys.  
What was the ration of the number of girls to the number of boys?

- (1) 11 : 17
- (2) 17 : 28
- (3) 17 : 11
- (4) 28 : 17

( )

11. The solid below is made up of 1-cm cubes.  
How many more 1-cm cubes are needed to build a cube of edge 4 cm?

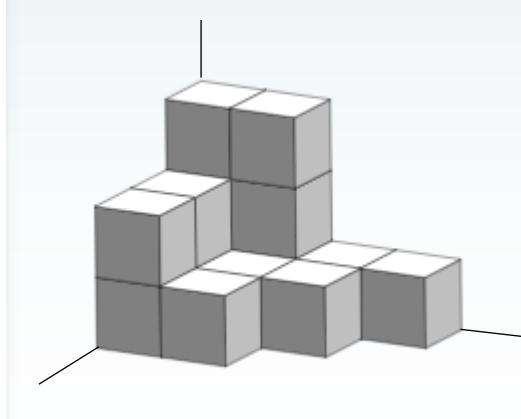

- (1) 28  
(2) 36  
(3) 49  
(4) 53

( )

12. The figure is made up of 2 identical quarter circles in a rectangle.  
Find the perimeter of the shaded part. (Take  $\pi = 3.14$ )

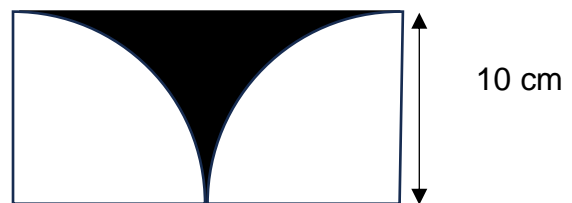

- (1) 31.4 cm  
(2) 35.7 cm  
(3) 51.4 cm  
(4) 78.5 cm

( )

13. The doctor prescribed 30 ml of cough syrup for Nigel. He had to take 5 ml of the cough every 3 hour. He first took his cough syrup at 4 a.m. When would his last intake be?

- (1) 4 p.m.
- (2) 6 p.m.
- (3) 7 p.m.
- (4) 10 p.m.

( )

14. Which of the following is **not** a net of a cube?

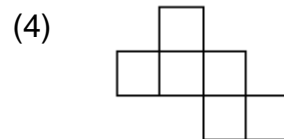
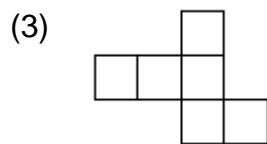
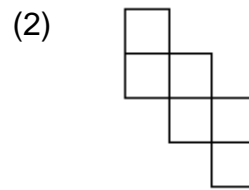
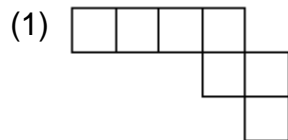

( )

15. Lisa spent 20% of her money on a blouse. She used the rest of the money to buy a skirt and a bracelet. The skirt cost \$24 more than the blouse. The bracelet cost \$72. Find the cost of the bag.

- (1) \$16
- (2) \$48
- (3) \$40
- (4) \$32

( )

**Booklet B: (25 marks)**

**Questions 16 to 20 carry 1 mark each. Write your answers in the spaces provided. For questions which require units, give your answers in the units stated. The use of calculators is NOT allowed.**

**(5 marks)**

16. Write  $3 + \frac{3}{10} + \frac{215}{1000}$  as a decimal.

Ans: \_\_\_\_\_

17. Find the value of  $68 - 12 \div 2 + 13$ .

Ans: \_\_\_\_\_

18. 7 women donated a total of \$1470.  
What is the average amount donated by each woman?

Ans: \$ \_\_\_\_\_

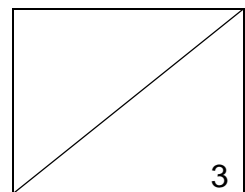

19. Express  $\frac{1}{8}$  as a decimal.

Ans: \_\_\_\_\_

20. Ms Siti drove for 6 h 15 min from her house in Singapore to visit her relative in Malaysia. She spent 2 h 45 min at her relative's house and left the house at 5 p.m. What time did she start driving from her house?

Ans: \_\_\_\_\_

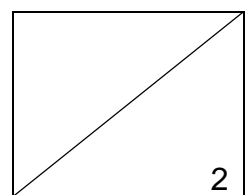



Questions 21 to 30 carry 2 marks each. Show your working clearly and write your answers in the spaces provided. For questions which require units, give your answers in the units stated. The use of calculators is NOT allowed.

(20 marks)

21. Lollipops were sold by mass as shown.

**Lollipops for Sale!**

First 100 g : \$5  
Every additional 50 g : \$2



Jake bought a packet of lollipops which weighed 250 g.  
How much did he pay?

Ans: \$ \_\_\_\_\_

22. In the figure, ABCD is a square.  $AB = EB$  and  $\angle BAE = 65^\circ$ . Find  $\angle BCE$ .

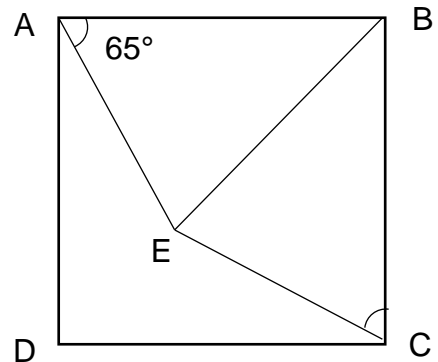

Ans: \_\_\_\_\_ °

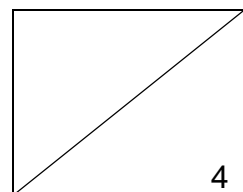

23. Rahmat is at Point X and he is facing North-West. Which point will Rahmat be facing after turning 90° anti-clockwise?

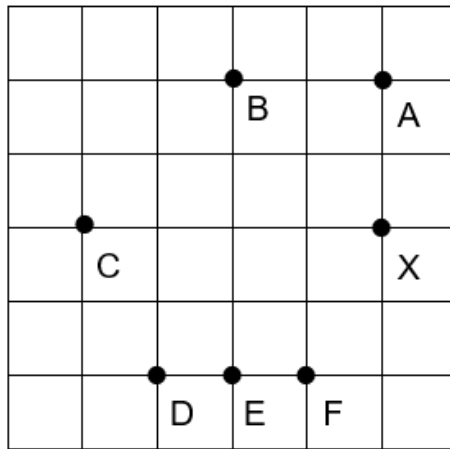

Ans: Point \_\_\_\_\_

24. Find the value of  $103 - 3m \times \frac{2m}{3}$  when  $m = 9$ .

Ans: \_\_\_\_\_

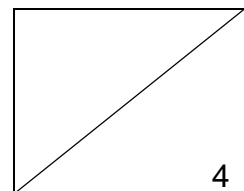

25. A cuboid of height 10 cm has a square base of side 3 cm.  
What is the volume?

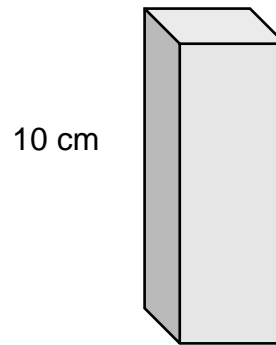

Ans: \_\_\_\_\_  $\text{cm}^3$

26. Lynn bought  $3z$  packets of stamps. Each packet contained 8 stamps. She gave 27 stamps to her friends and divided the rest of the stamps equally into 7 boxes. How many stamps were there in each box? Give your answer in terms of  $z$  in the simplest form.

Ans: \_\_\_\_\_

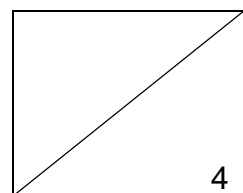

27. At first, the ratio of Harry's savings to Jenny's savings was 5 : 4. After each of them spent \$50, the ratio of Harry's savings to Jenny's savings became 13 : 10. What was the Jenny's savings at first?

Ans: \$ \_\_\_\_\_

28. A total of 115 people stand in a queue for tickets to watch a magic show. There are at least 3 men between any 2 women. What is the largest number of women in the queue?

Ans: \_\_\_\_\_

29. Sandra had 5 boxes of identical pencils. At first, each of the boxes contained the same number of pencils. She took 21 pencils from each box. After that, the total number of pencils left in the 5 boxes was equal to the total number of pencils in 2 of the boxes at first. What was the number of pencils in each box at first?

Ans: \_\_\_\_\_

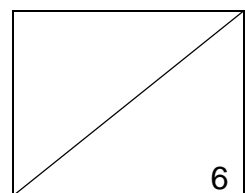

30. The bar graph below shows the number of watches sold by 4 stores in a month.

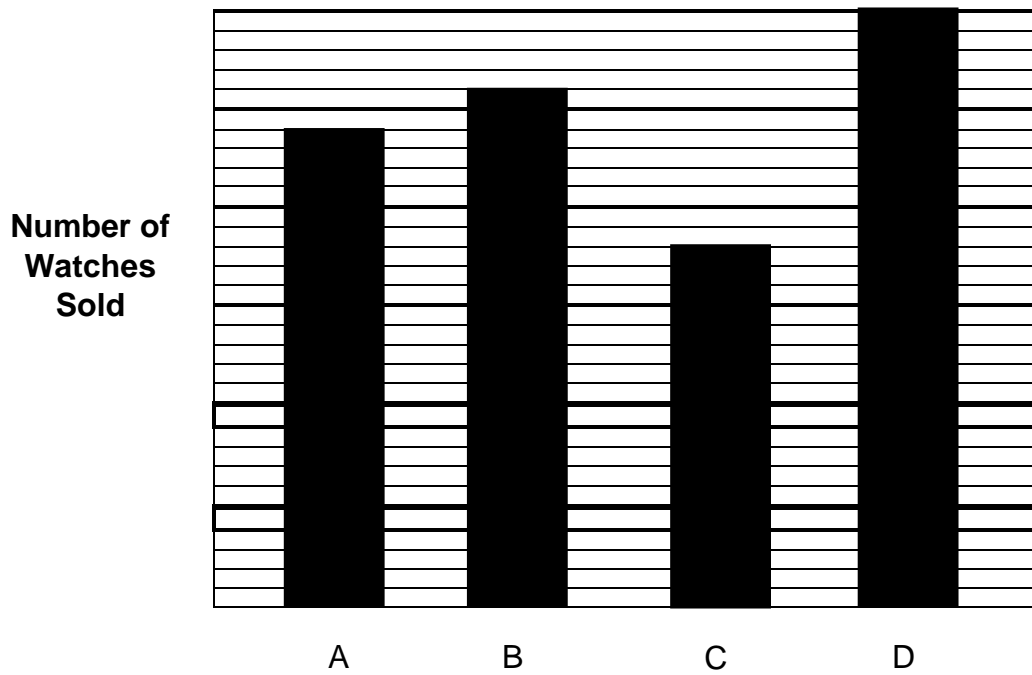

What fraction of the total number of watches was sold by Store B? Give your answers in the simplest form.

Ans: \_\_\_\_\_

